



**FUEL**CLOUD



**Extreme Weather**  
Installation Manual

Manual Version 1.4  
Revised 4/13/26



# Welcome to FuelCloud!

This installation guide contains all of the information you need to install your hardware, create your online account, and begin using FuelCloud.

**Before beginning physical installation of your FuelCloud hardware, create an account at [fuelcloud.com](https://fuelcloud.com)** and register your device's serial number to your account. Physical installation cannot be completed without an online account.

For help on the FuelCloud website, please see the Quick Setup Guide video on the dashboard.



**Get the installer app today!**



# Table of Contents

Privacy Statement / FCC Statement / Terms and Conditions	3
Compatibility & Specs	4
<hr/>	
<b>Before Installation</b>	
Hardware and Install Warnings	6
Additional Warnings	9
Check List	10
Identify Your Installation Location	11
<hr/>	
<b>Installation</b>	
Mounting	12
Wiring	13
Internet Configuration	17



## Privacy Statement

FuelCloud is committed to protecting user's privacy. For more information about FuelCloud's privacy policy, please review our full terms and conditions at: [fuelcloud.com/privacy-policy](https://fuelcloud.com/privacy-policy)



## FCC Statements

Find complete details of our FCC compliance at:  
[fuelcloud.com/fcc-compliance](https://fuelcloud.com/fcc-compliance)



## Terms and Conditions

For a complete terms and conditions, including warranty disclaimers visit: [fuelcloud.com/terms-condition](https://fuelcloud.com/terms-condition)

## **Compatibility & Specs**

The Extreme Weather Enclosure is compatible with 10th and 11th generation iPads. To check your iPad model, open your iPad's **Settings App** and go to **General > About**.

<b>Input Power Requirements</b>	120VAC, 50/60Hz <b>USB-C iPad charger:</b> 0.5A <b>Thermostat Heater:</b> 1.66A <b>Thermostat Fan:</b> 0.1A
<b>iPad Compatibility</b>	10th generation 11th generation
<b>Dimensions</b>	<b>Height:</b> 15.5" (393mm) <b>Width:</b> 13.3" (339mm) <b>Depth:</b> 8.3" (201mm)
<b>Weather Ratings</b>	NEMA 3R, 3Rx / IP24
<b>Temperature Ratings</b>	Adjustable heater & fan. Preset at: <ul style="list-style-type: none"><li>• Heater on at 45F (7C)</li><li>• Fan on at 80F (26C)</li></ul>
<b>I/O</b>	Wi-Fi Ethernet (optional)

## Declaration of Conformity:

Hereby, FuelCloud, declares that this Extreme Weather is in compliance with the essential requirements and other relevant provisions of Directive 2014/53/EU. The full text of the EU declaration of conformity is available at the following internet address: [URL of DoC]

FuelCloud vakuuttaa täten että Extreme Weather tyyppinen laite on direktiivin 2014/53/EU oleellisten vaatimusten ja sitä koskevien direktiivin muiden ehtojen mukainen. The full text of the EU declaration of conformity is available at the following internet address: [URL of DoC]

Hierbij verklaart FuelCloud dat het toestel Extreme Weather in overeenstemming is met de essentiële eisen en de andere relevante bepalingen van richtlijn 2014/53/EU. The full text of the EU declaration of conformity is available at the following internet address: [URL of DoC]

Bij deze verklaart FuelCloud dat deze Extreme Weather voldoet aan de essentiële eisen en aan de overige relevante bepalingen van Richtlijn 2014/53/EU. The full text of the EU declaration of conformity is available at the following internet address: [URL of DoC]

Par la présente FuelCloud déclare que l'appareil Extreme Weather est conforme aux exigences essentielles et aux autres dispositions pertinentes de la directive 2014/53/EU. The full text of the EU declaration of conformity is available at the following internet address: [URL of DoC]

Par la présente, FuelCloud déclare que ce Extreme Weather est conforme aux exigences essentielles et aux autres dispositions de la directive 2014/53/EU qui lui sont applicables. The full text of the EU declaration of conformity is available at the following internet address: [URL of DoC]

Hiermit erklärt FuelCloud, dass sich dieser/diese/dieses Extreme Weather in Übereinstimmung mit den grundlegenden Anforderungen und den anderen relevanten Vorschriften der Richtlinie 2014/53/EU befindet". (BMW) The full text of the EU declaration of conformity is available at the following internet address: [URL of DoC]

ΜΕ ΤΗΝ ΠΑΡΟΥΣΑ FuelCloud ΔΗΛΩΝΕΙ ΟΤΙ Extreme Weather ΣΥΜΜΟΡΦΩΝΕΤΑΙ ΠΡΟΣ ΤΙΣ ΟΥΣΙΩΔΕΙΣ ΑΠΑΙΤΗΣΕΙΣ ΚΑΙ ΤΙΣ ΛΟΙΠΕΣ ΣΧΕΤΙΚΕΣ ΔΙΑΤΑΞΕΙΣ ΤΗΣ ΟΔΗΓΙΑΣ 2014/53/EU. The full text of the EU declaration of conformity is available at the following internet address: [URL of DoC]

Con la presente FuelCloud dichiara che questo Extreme Weather è conforme ai requisiti essenziali ed alle altre disposizioni pertinenti stabilite dalla direttiva 2014/53/EU. The full text of the EU declaration of conformity is available at the following internet address: [URL of DoC]

Por medio de la presente FuelCloud declara que el Extreme Weather cumple con los requisitos esenciales y cualesquiera otras disposiciones aplicables o exigibles de la Directiva 2014/53/EU. The full text of the EU declaration of conformity is available at the following internet address: [URL of DoC]

FuelCloud declara que este Extreme Weather está conforme com os requisitos essenciais e outras disposições da Directiva 2014/53/EU. The full text of the EU declaration of conformity is available at the following internet address: [URL of DoC]



BEFORE INSTALLATION

## Hardware and Install Warnings

Installations must be in accordance with the National Electrical Code (NFPA No. 70) and the Automotive and Marine Service Station Code (NFPA No. 30A). The installer is responsible for investigating and following any applicable local codes.

### Restricted Access:

Access can only be gained by service persons or by users who have been instructed about the reasons for the restrictions applied to the location and about any precautions that shall be taken.

Access is through the use of a tool or lock and key, or other means of security, and is controlled by the authority responsible for the location.

Seal offs must be used when conduit is exiting an explosion proof zone. (class 1 div 1 or class 1 div 2)

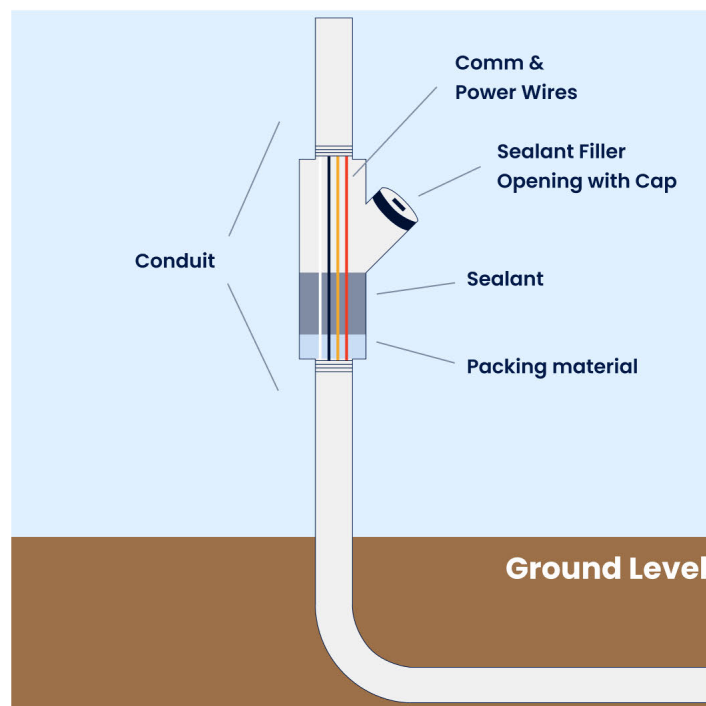

**Hazardous Area** (Where not to mount the CloudBox):

Do not mount the CloudBox or any FuelCloud device within the hazardous / classified area.

**Hazardous Zones:**

Dispensing Device	Class 1 Div 1	Class 1 Div 2
Compressed natural gas (CNG)	Entire space within the dispenser enclosure.	1.5 m (5 ft) in all directions from the dispenser enclosure.
Liquefied natural gas (LGN)	Entire space within the dispenser enclosure.	3 m (10 ft) in all directions from the dispenser enclosure.
Liquefied petroleum gas (LP-Gas)	Entire space within the dispenser enclosure; 450 mm (18 in.) from the exterior surface of the dispenser enclosure to an elevation of 1.22 m (4 ft) above the base of the dispenser; the entire pit or open space beneath the dispenser and within 6 m (20 ft) horizontally from any edge of the dispenser when the pit or trench is not mechanically ventilated.	Up to 450 mm (18 in.) above ground and within 6 m (20 ft) horizontally from any edge of the dispenser enclosure, including pits or trenches within this area when provided with adequate mechanical ventilation.

\*Pulled from NEC 2018

# Hazardous Area Examples:

Classified areas adjacent to dispenser mounted on aboveground storage tank:

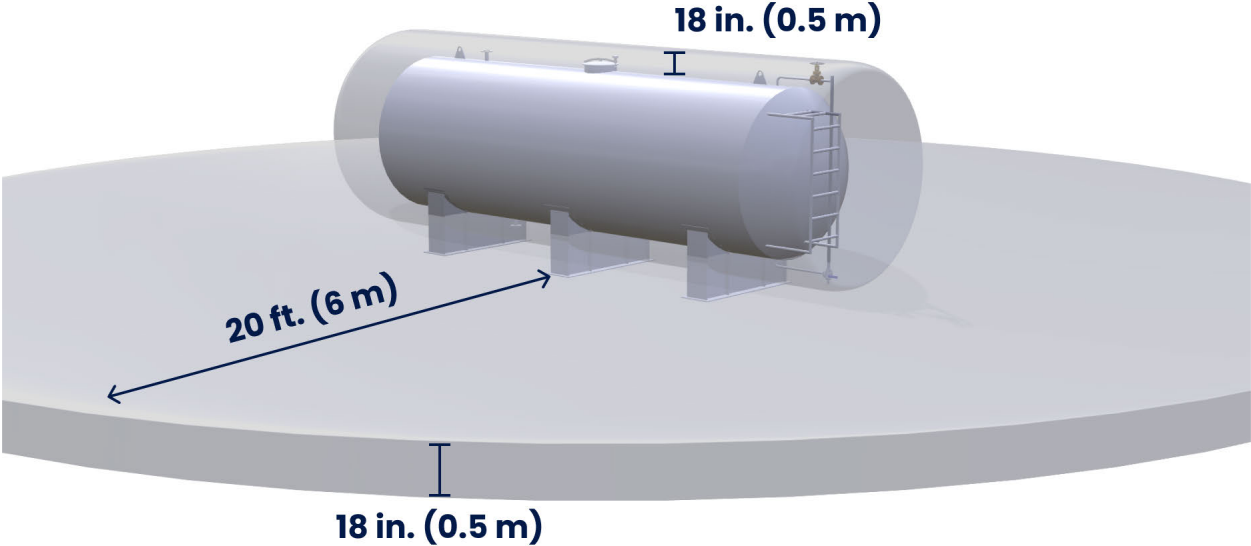

Classified areas adjacent to dispensers:

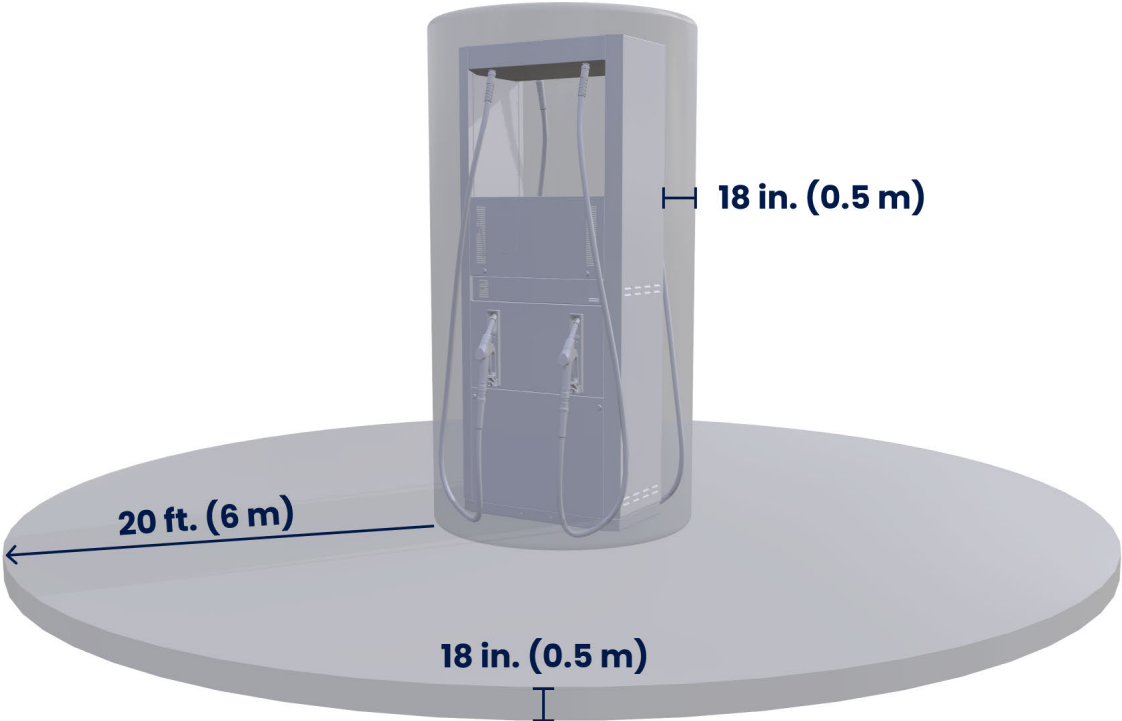

### **Wireless Warnings:**

The total wireless range of the CloudBox is 75' of line of site. To ensure best performance, do not install the Extreme Weather Enclosure in a location where the signal can be blocked or degraded.

### **Additional Warnings:**

**External Devices:** All peripheral equipment connected to the CloudBox system must be UL and CSA listed.



BEFORE INSTALLATION

## Check List

Complete the following steps before beginning installation of FuelCloud hardware. Failure to perform the below checks may result in the FuelCloud system or fuel equipment being damaged or not working as intended.

- 1** Turn off all power to the pump and tank.
- 2** Ensure that your installation location meets the following physical requirements:
  - ✓ Clear line of site to pump **or** located where wireless signal will not be blocked or degraded.
  - ✓ No wiring obstructions.
  - ✓ Good cellular connectivity.
  - ✓ Hardware will be mounted outside of hazardous zones – see **warnings** for more information.
  - ✓ Hardware dimensions for mounting: 15.5"H x 13.3"W x 8.3"D (393mm H x 339mm W x 201mm D).
- 3** Ensure that your site power supply and fuel equipment is compatible with FuelCloud's hardware. See **Compatibility & Specs** for more information.



BEFORE INSTALLATION

# Identify Your Installation Location

Ensure the following:

- Line of sight to the CloudBox
- Good LTE cellular coverage
- Fueling within 75' of the CloudBox





## INSTALLATION Mounting

Mount the Extreme Weather Enclosure onto a flat surface.  
(Mounting hardware not supplied)

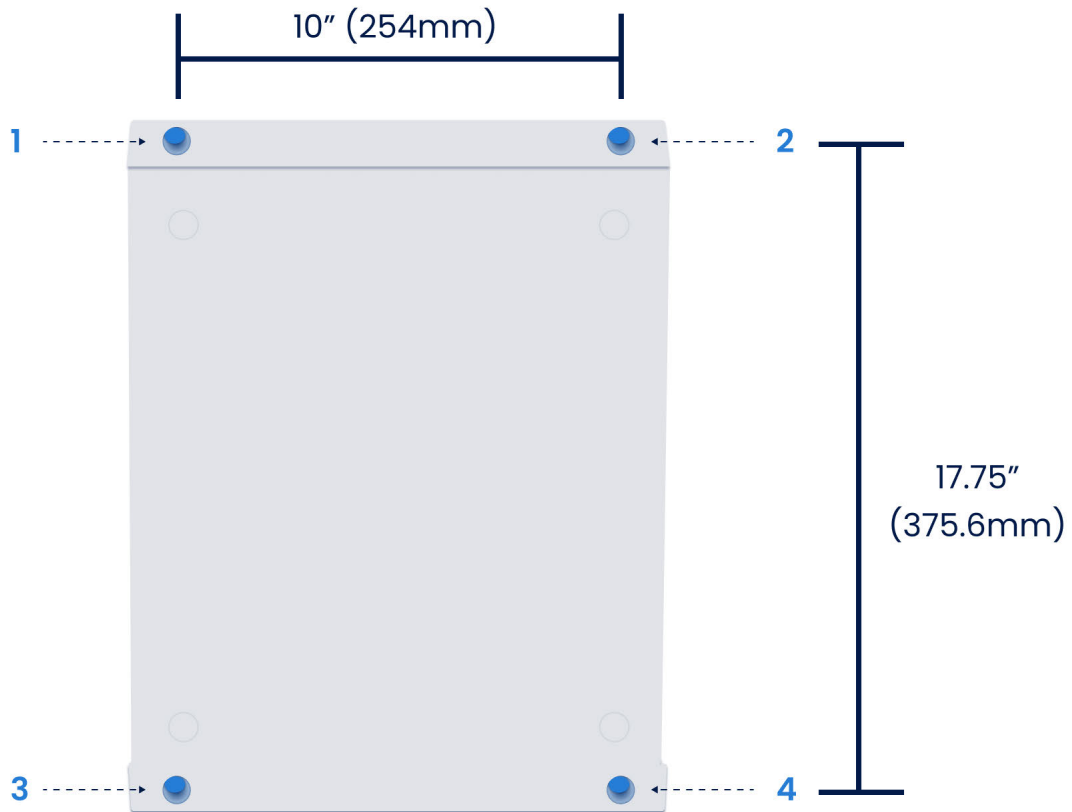



## INSTALLATION Wiring

- 1 Remove the 4 bolts holding the iPad plate inside the enclosure.

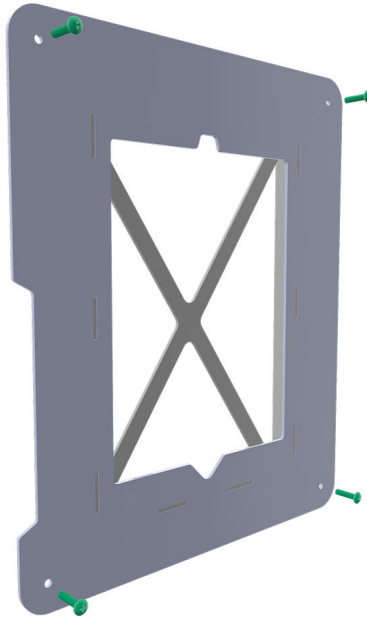

- 2 Connect Neutral, Ground, and Hot from the power supply to the iPad enclosure.

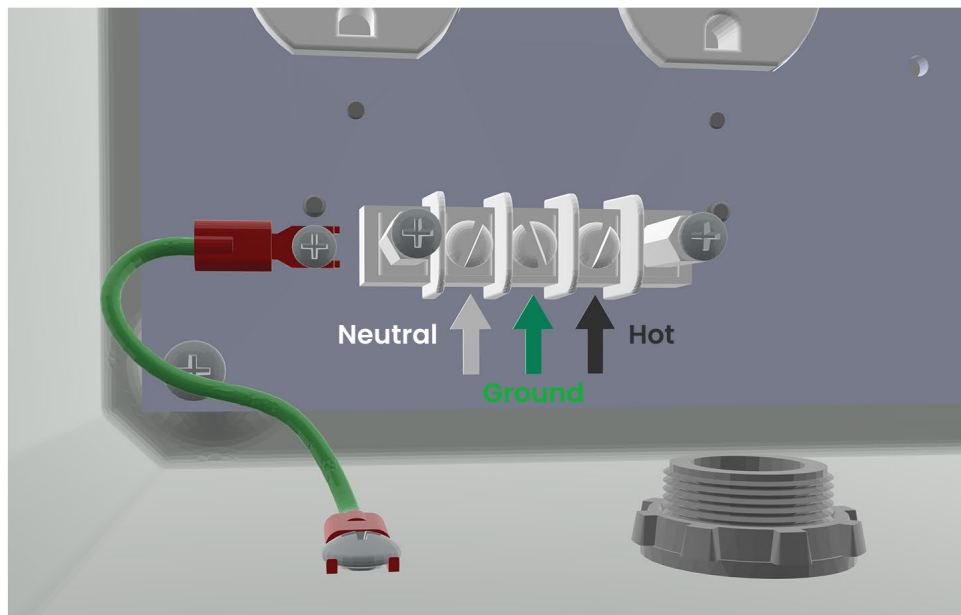



## INSTALLATION Wiring

- 3 Ensure that the fan thermostat (blue) is set to 80F and the heater thermostat (red) is set to 45F. These control temperatures can be adjusted based on climate.

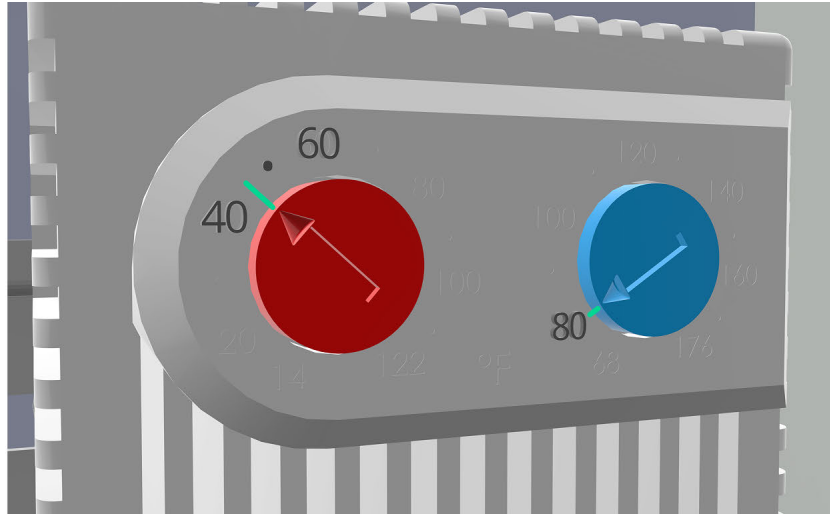

- 4 Plug the AC to USB-C iPad charger into one of the 4 outlets inside the enclosure.

Make sure the USB-C cable is connected with the AC adapter

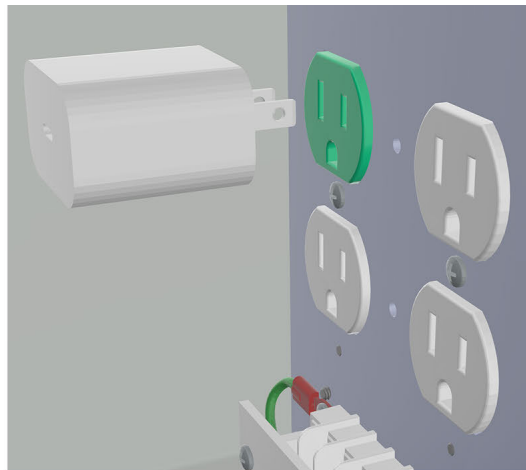

 INSTALLATION  
**Wiring**

- 5 Slide the iPad (with case) into the iPad plate.

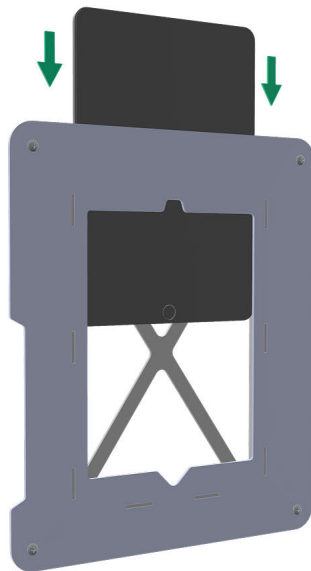

- 6 Connect the USB-C cable between the iPad and the USB-C charger.

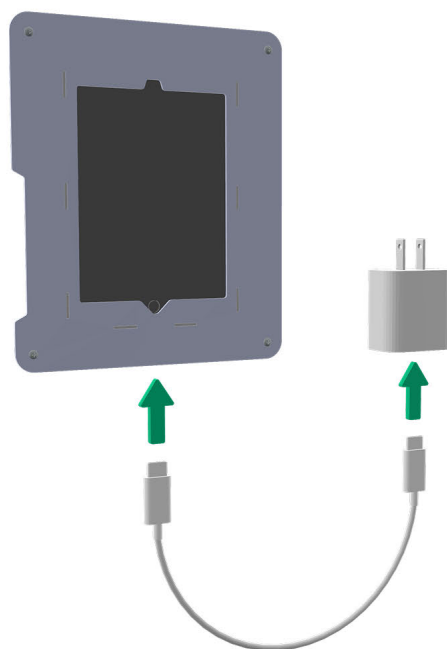



## INSTALLATION Wiring

- 7 Reattach the iPad plate with the original 4 bolts.

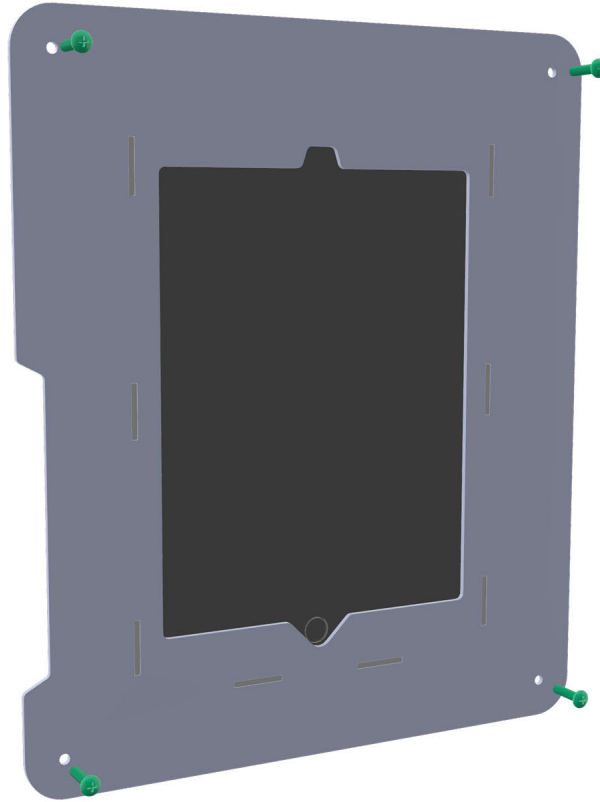



INSTALLATION

# Internet Configuration

## Cellular:

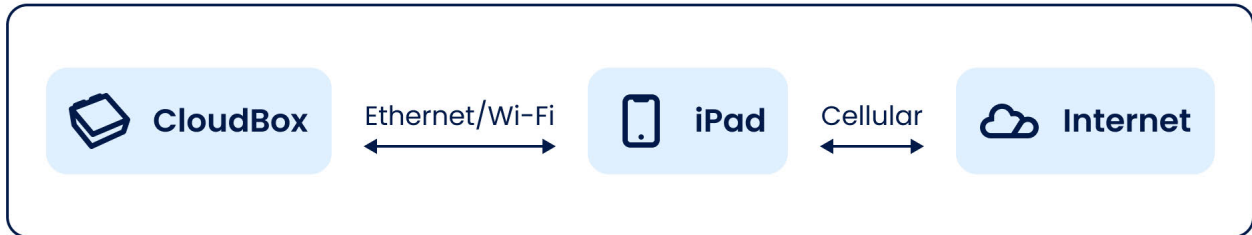

The iPad can communicate with the internet through cellular. The iPad will then communicate with the CloudBox over Wi-Fi or ethernet. **FuelCloud recommends connecting the iPad directly to the CloudBox with the included ethernet cable.**

## Company Ethernet:

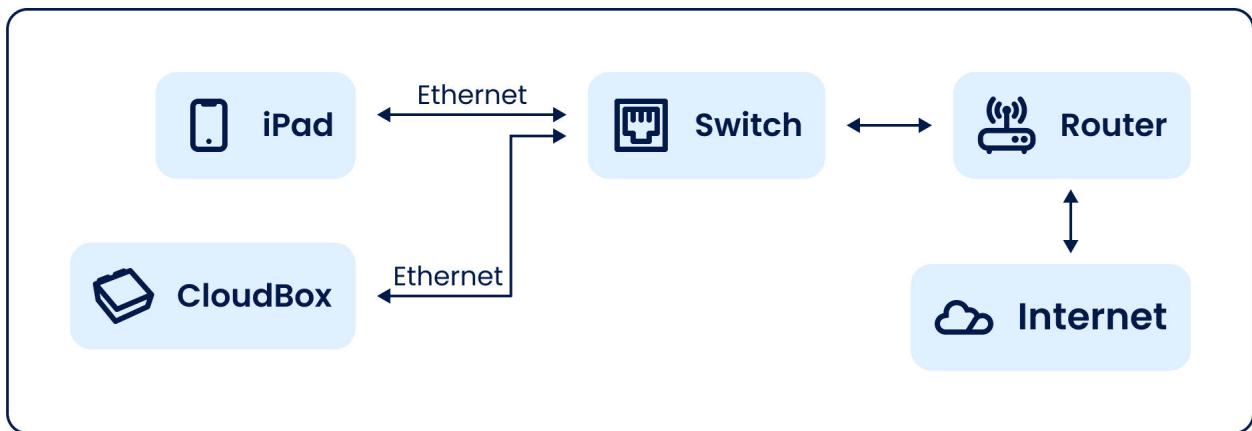

Connect the iPad, CloudBox, and router to an ethernet switch. If you did not purchase an optional ethernet switch, connect both directly to the router.



**Note:** For ethernet with a switch, the CloudBox will need to be on “client” mode.

## Wi-Fi:

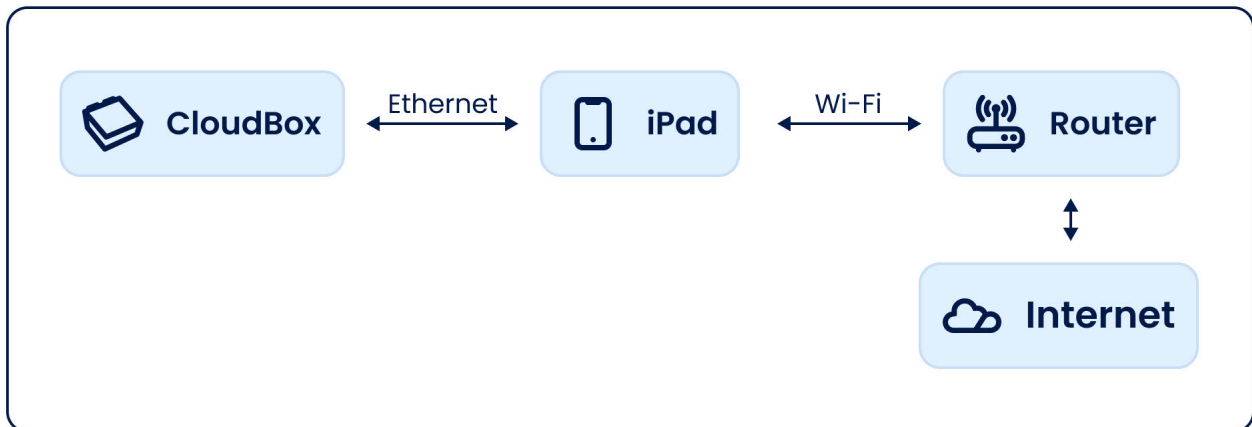

If cellular and hardwired ethernet are not options for connecting the iPad to the internet, the iPad can be connected to a Wi-Fi network. You will need to enter both the SSID and the password to bring the iPad online. The CloudBox can be connected directly to the iPad through ethernet.

**Alternatively, the CloudBox can be connected to the same SSID:**

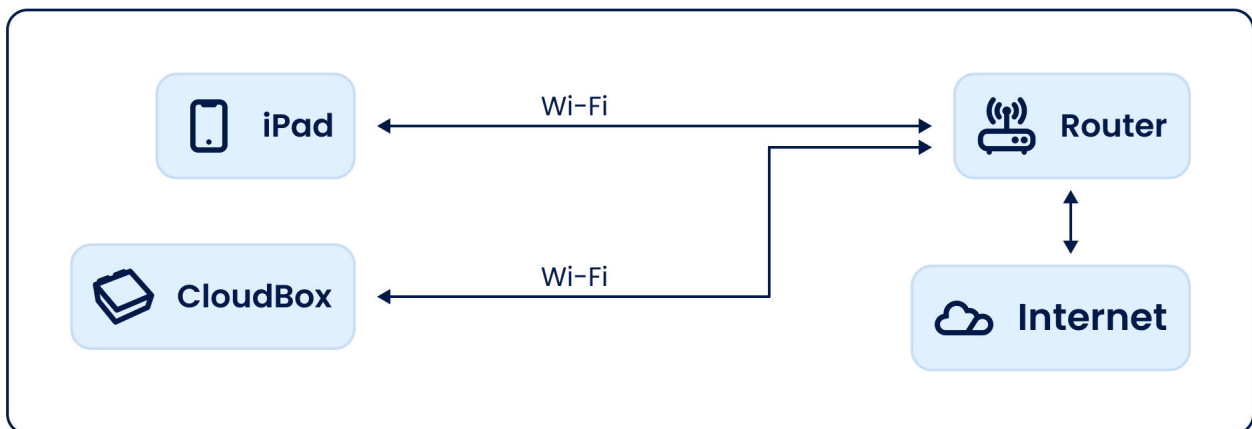



**Revised 4/13/26**

FuelCloud OPCO, LLC  
124 SW Dennis Ave  
Hillsboro, OR 97123